

# Hardware

For Windows & Doors



# The finishing touches

Hardware solutions by AWS.

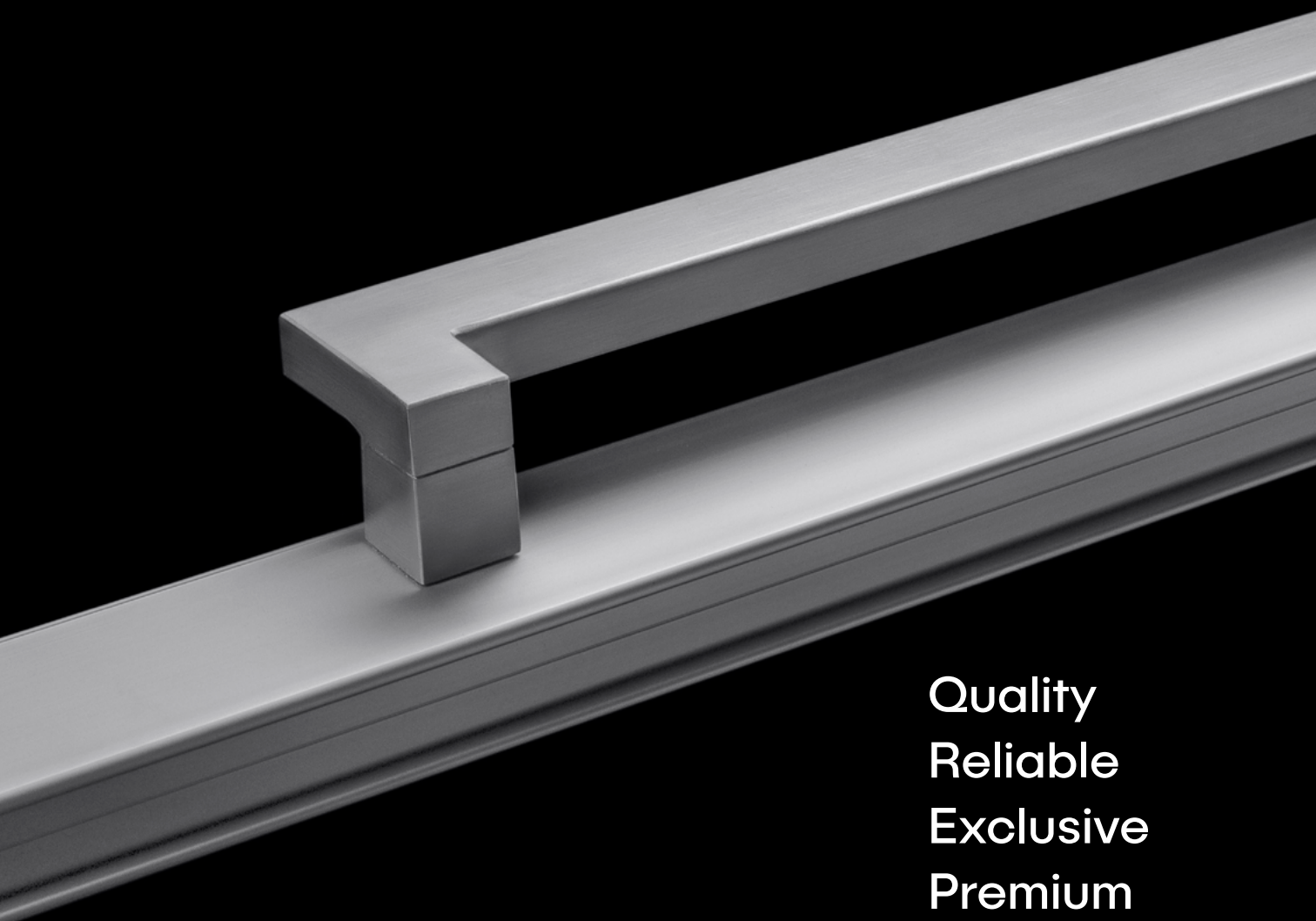

Quality  
Reliable  
Exclusive  
Premium  
Functional

Beautiful hardware combines form and function to transform a house into a home. It's a defining feature reflecting who you are.

We offer three unique and stylish suites of purpose-designed hardware to complement the performance and styling of Vantage® and Elevate™ window and door systems.

The right solution is the one that's right for you, and we've been getting it right in Australian homes and commercial applications for more than 24 years.

## Contents

Our Ranges	02
Choosing the right hardware	04
ANDO™	06
ICON™	28
MIRO™	44
Additional Hardware Options	60
Hardware Compatibility	72
Colour	75
Care & Maintenance	76
Warranty	77

# Our Ranges

Each of our hardware ranges are uniquely styled to offer you a variety of options for your windows and doors.



## Form and Function

Crafted to complement the clean, modern design of Vantage® Designer Series windows and doors, the ANDO™ range brings a clean and refined look to your home or commercial project.

ANDO™ is a comprehensive range of hardware that is easily tailored to your needs. It is available in a variety of finishes including colour matched powder coats.



icon



## Strength and Integrity

ICON™ is a range of 316-grade stainless steel hardware for aluminium windows and doors. It offers superior weathering performance and outstanding durability making it suitable for all environments.

Developed for use with our high-performance window systems, ICON™ incorporates a square-edged, linear look. It's the perfect finishing touch to complement our Designer or Architectural Series windows and doors.

ICON™ is manufactured from 316-grade stainless steel.



miro

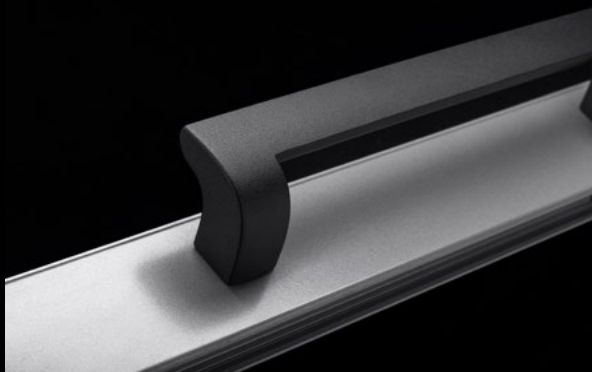

## Contemporary Style

MIRO™ hardware offers a textured, matte black finish, ergonomic operation for greater accessibility and beautiful curved aesthetics.

Purpose designed for use in harsh environments, the cast aluminium body incorporates our exclusive Enduratec™ finishing technology, tested to deliver 10 times the corrosion resistance of traditional powdercoat finishes.

Compatible with Architectural, Residential and Designer Series windows and doors, MIRO™ is an appealing choice for any application.

# Choosing the right hardware for your project.

When thinking about hardware selection for your home it is important to consider that the locks and handles you choose will not only provide security but also represent the element of your windows and doors you will interact with most regularly. There are a number of important considerations when selecting hardware for your windows and doors.

## Accessibility & Operation

Should the handle or lever be compliant with disability standards to ensure the long-term livability for your home?

If so, AWS offers a number of hardware options which make access for individuals with reduced dexterity easier and a number of options which comply with the requirements for disability access as outlined in AS1428.1-2009 Design for Access.



### **AS1428.1-2009 Compliant**

If AS1428.1-2009 compliance is a priority, look for hardware options marked with this symbol.



### **Accessibility Focused**

If compliance isn't essential but enhanced accessibility features are important, look for hardware options marked with this symbol.

## Colour Matched Finish

Hardware can be a defining statement in your home and the ability to select from a range of colours to compliment your internal colour scheme is important.

The ANDO™ range of hardware allows for colour matched options.



### **Colour Matched**

If the ability to colour match your hardware is a priority, choose from hardware items with this symbol.

## Bushfire Prone Areas

AWS offers a wide range of window and door systems tested for use in BAL-40 applications. Not all our hardware has been through the testing process.



### **BAL-40 Tested**

If you are building in a BAL-40 application where you wish to use a tested window or door system, select from hardware with this symbol.

# Harsh Envrionments and Coastal Applications

Coastal applications are renowned for having harsh environmental conditions which can impact the long term integrity of your hardware. AWS offers two hardware ranges which are well suited for use in coastal applications though neither will be immune to the impacts of this harsh environmental condition.



## Enduratec™ Finish Technology

Our unique range of MIRO™ hardware with Enduratec™ Finish Technology is a great solution for areas subjected to harsh environmental conditions, such as coastal applications but where a cost effective and low maintenance solution is preferred.

Hardware coated with Enduratec™ Finish Technology performs up to 10 times better than standard powder coat hardware when tested in a neutral salt bath for corrosion resistance.

The unique Enduratec™ Finish incorporates a stylish matt appearance and requires very little maintenance to keep it looking great. Hardware should be wiped over with a damp cloth or mild soapy water every 3–6 months.

We are so confident about the performance of Enduratec™ coated hardware we are prepared to warrant these items against finish defects even in applications less than 5km from the coast.

### Enduratec™ Finish Technology

If you are looking for hardware items available with Enduratec™ Finish Technology, select from items marked with this symbol.

## Stainless Steel Hardware

Stainless steel hardware is our premium offering for use in harsh environmental conditions. Made from 316 grade stainless steel, ICON™ hardware will provide excellent longevity and performance.

Stainless steel is resistant to rust but not immune to it. Stainless steel will rust, commonly identified by the discolouration you might see on stainless steel hardware. This is referred to as tea staining.

To minimise the risk of tea staining occurring, hardware must be kept clean and free from contaminants. Frequent cleaning is a requirement.

### Stainless Steel

If you are seeking a premium solution for a coastal or harsh environment application, select hardware items marked with this symbol.







# Single Point Sliding Door Lock

Surface-mounted to the door with an integrated single point locking mechanism, this strong and bold handle delivers modern design and clean lines.

## Suitable for use with:

- 541** Residential Sliding Door
- 542** Residential Stacking Sliding Door
- 618** MAGNUM™ Sliding Door
- 442** Commercial Stacking Sliding Door
- 642** Commercial Stacking Sliding Door (150mm)
- 471** Apartment Sliding Door
- 702** SlideMASTER™ Sliding Door (External Sliding)
- 704** SlideMASTER™ Sliding Door (Internal Sliding)

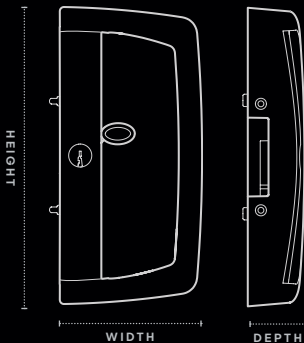

**Height** 216mm  
**Width** 102.5mm  
**Depth** 41mm



# Twin Point Sliding Door Lock

This powerful square-form handle incorporates a twin actuated locking mechanism. Surface-mounted to the door, this handle makes a stylish and highly functional design statement with the added security of 2-point locking.

## Suitable for use with:

- 541** Residential Sliding Door
- 542** Residential Stacking Sliding Door\*
- 618** MAGNUM™ Sliding Door
- 442** Commercial Stacking Sliding Door\*
- 471** Apartment Sliding Door\*
- 642** Commercial Stacking Sliding Door (150mm)\*
- 702** SlideMASTER™ Sliding Door (External Sliding)
- 704** SlideMASTER™ Sliding Door (Internal Sliding)
- 704T** SlideMASTER™ Sliding Door (Top Hung)
- 704B** SlideMASTER™ Sliding Door (Bottom Rolling)
- 704R** SlideMASTER™ Sliding Door (Recessed)

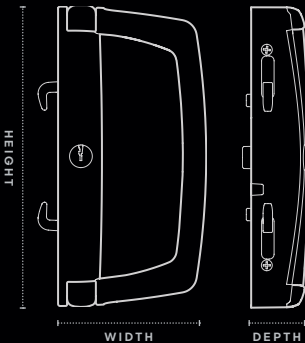

**Height** 216mm  
**Width** 107mm  
**Depth** 41mm

\* if panels are above 2400mm high, the slimline handle must be used.



# Slimline Sliding Door Lock

This lock's twin actuated locking mechanism delivers a high performance locking system for your home. There is no lever or D-pull to protrude over the glass, ensuring clean lines and a sleek appearance.

## Suitable for use with:

- 541** Residential Sliding Door
- 542** Residential Stacking Sliding Door
- 601/2** MAGNUM™ Sliding Window
- 618** MAGNUM™ Sliding Door
- 442** Commercial Stacking Sliding Door
- 461** Apartment Sliding Window
- 642** Commercial Stacking Sliding Door (150mm)
- 471** Apartment Sliding Door
- 462** Architectural Sliding Window
- 702** SlideMASTER™ Sliding Door (External Sliding)
- 704** SlideMASTER™ Sliding Door (Internal Sliding)

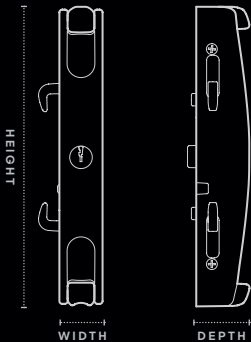

**Height** 216mm  
**Width** 31.5mm  
**Depth** 38.5mm



 Colour Matched

 Stainless Steel

 BAL-40 Tested

# Sliding Door Pull Handle

This elegant D-pull handle offers a sleek and contemporary alternative to surface-mounted sliding door locks. The large aperture is suitable for a wide range of residential and commercial applications.

This handle is manufactured from stainless steel and available in a natural Stainless Steel finish or with colour matched powder coat finish

## Suitable for use with:

- 618** MAGNUM™ Sliding Door
- 50** Commercial Door (Single Beaded)
- 51** Light Commercial Door
- 52** Commercial Door (Double Beaded)
- 702** SlideMASTER™ Sliding Door (External Sliding)
- 704** SlideMASTER™ Sliding Door (Internal Sliding)
- 704R** SlideMASTER™ Sliding Door (Recessed)
- 704B** SlideMASTER™ Sliding Door (Bottom Rolling)
- 704T** SlideMASTER™ Sliding Door (Top Hung)
- 731** Thermally Broken Sliding Door
- 852** Thermally Broken Sliding Door

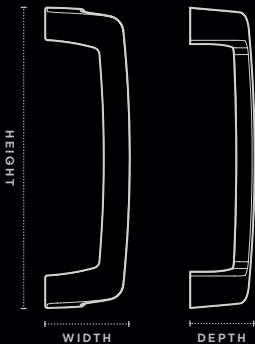

**Height** 237mm  
**Width** 66.5mm  
**Depth** 50.5mm

NOTE: Available either as stainless steel or with powder coat finish, not both.



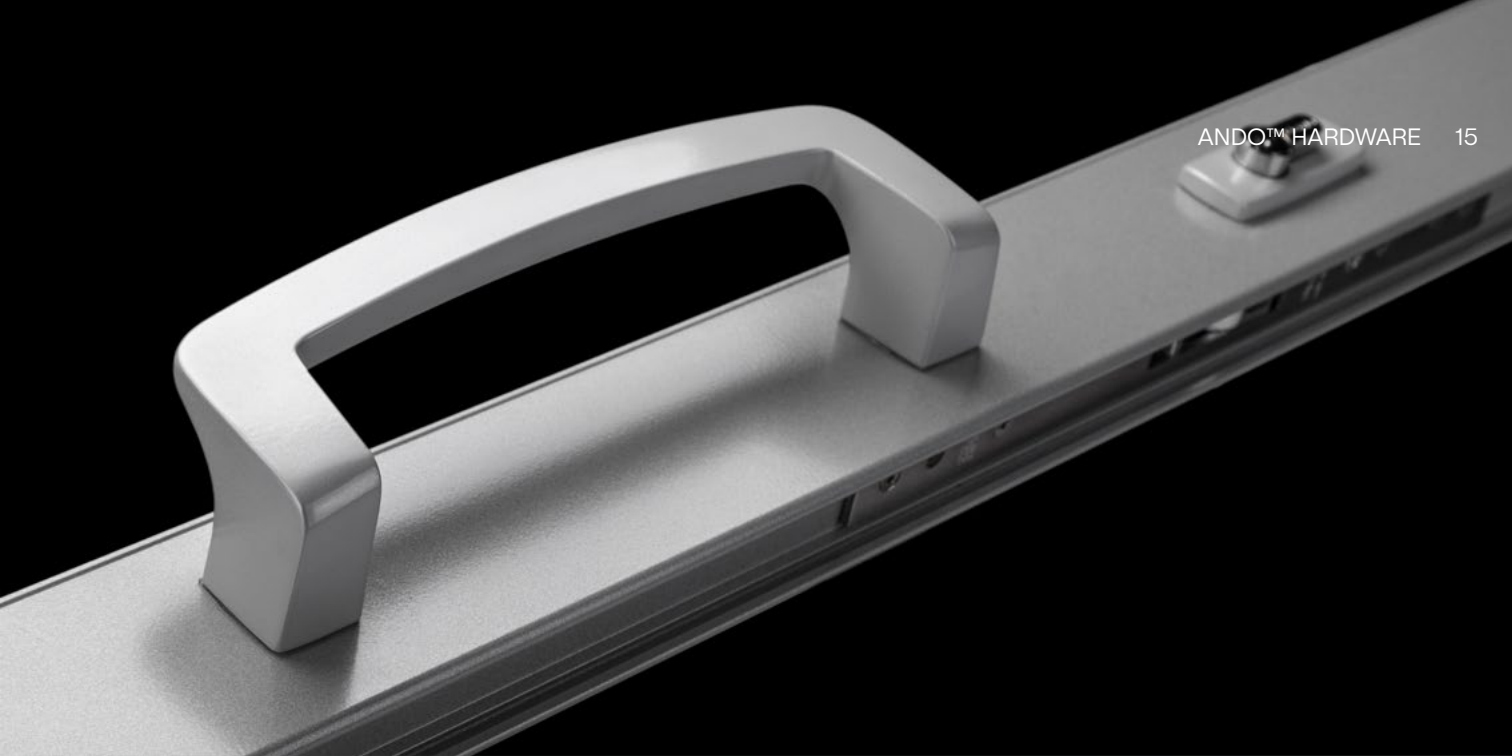

**CM** Colour Matched

**SS** Stainless Steel

**BAL-40 Tested**

# Hinged Door Lock

A highly versatile lever handle with a clean and compact design.

This hinged door lock is available either as stainless steel or with a powder coat finish.

Available as:

- 2-point lock – single locking
- 4-point lock – multi locking
- lever compression locking

## Suitable for use with:

<b>548</b>	High Performance Bi-fold Door	<b>729</b>	Thermally Broken Hinged Door
<b>549</b>	Hinged Entry Door	<b>730</b>	Thermally Broken Bi-fold Door
<b>50</b>	Commercial Door (Single Beaded)	<b>831</b>	Thermally Broken E3 Bi-fold Door
<b>51</b>	Light Commercial Door	<b>832</b>	Thermally Broken Bi-fold Door
<b>52</b>	Commercial Door (Double Beaded)	<b>852</b>	Thermally Broken Door
<b>410</b>	FoldMASTER™ Bi-fold Door (Bottom Rolling)		
<b>411</b>	FoldMASTER™ Bi-fold Door (Top Hung)		
<b>412</b>	ViewMASTER™ Bi-fold Door (Bottom Rolling)		
<b>650</b>	Architectural Hinged Door		

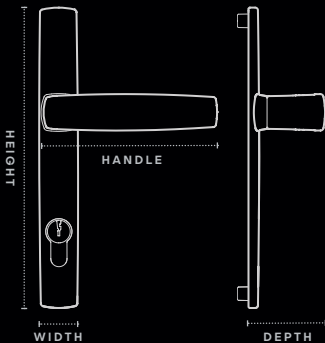



**Height** 241.5mm  
**Width** 27.5mm  
**Handle** 125mm  
**Depth** 54.5mm

NOTE: Available either as stainless steel or with powder coat finish, not both.



 Colour Matched

 Stainless Steel

 BAL-40 Tested

# Bi-fold Operator

The smooth, flush profile offers a discreet yet highly functional operator for use in our bi-fold windows and doors.

It is available with either a powder coat finish or as stainless steel.

This swivel operator pushes locking stainless steel bolts into the frame at the top and bottom of the panel. Separately-installed key locking is available upon request.

## Suitable for use with:

- 546** High Performance Bi-fold Window (Bottom Rolling)
- 548** High Performance Bi-fold Door (Bottom Rolling)
- 410** FoldMASTER™ Bi-fold Door (Bottom Rolling)
- 411** ViewMASTER™ Bi-fold Door (Top Hung)
- 412** ViewMASTER™ Bi-fold Door (Bottom Rolling)
- 730** Thermally Broken Bi-fold Door (Bottom Rolling)
- 831** Thermally Broken E3 Bi-fold Door (Bottom Rolling)
- 832** Thermally Broken Bi-fold Door (Bottom Rolling)

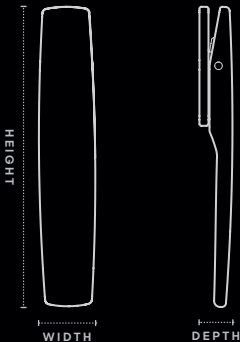

**Height** 149.5mm  
**Width** 28mm  
**Depth** 16.5mm

NOTE: Available either as stainless steel or with powder coat finish, not both.

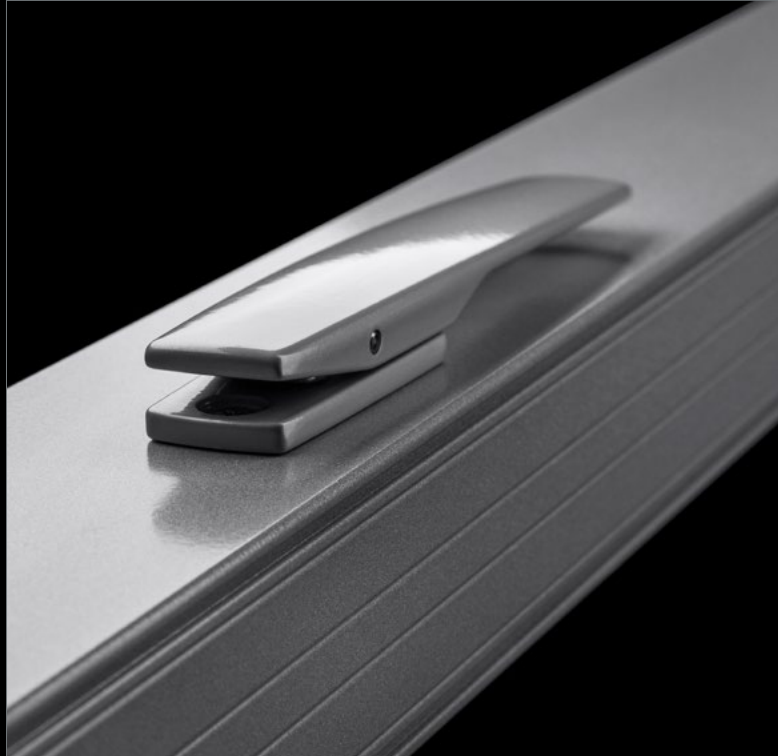

# Sliding Window Lock

A compact and streamlined window lock for a neat, flush finish. Perfect for applications where a minimalist style is desired. Push the operator into the body to slide the window open or closed. Key-lockable for security and peace of mind.

## Suitable for use with:

- 601/2** MAGNUM™ Sliding Window
- 461** Apartment Sliding Window
- 462** Architectural Sliding Window
- 662** Architectural Sliding Window (150mm)

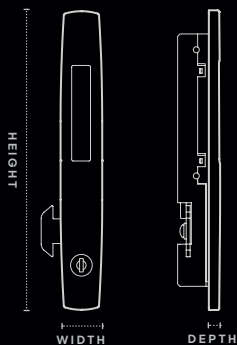

**Height** 190mm  
**Width** 26.5mm  
**Depth** 7.2mm



# Double Hung Lock

A simple and stylish lock for use with double hung windows which can be colour matched for a truly custom finish. Turn the latch to lock and unlock. Available in non-keyed or keyed finish for added security.

## Suitable for use with:

- 514** Residential Double Hung Window
- 613** MAGNUM™ Double Hung Window
- 453** Commercial Double Hung Window
- 463** Architectural Double Hung Window

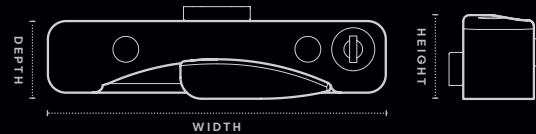
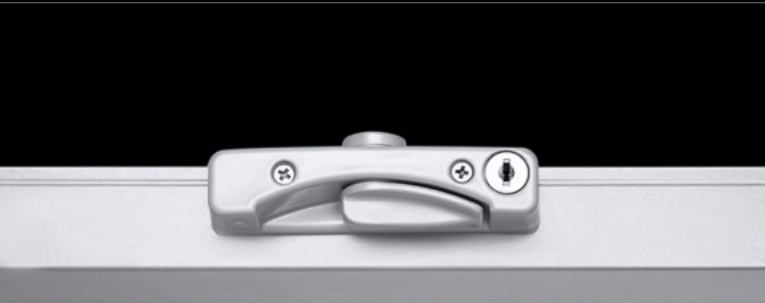

**Height** 28mm  
**Width** 114mm  
**Depth** 25.5mm



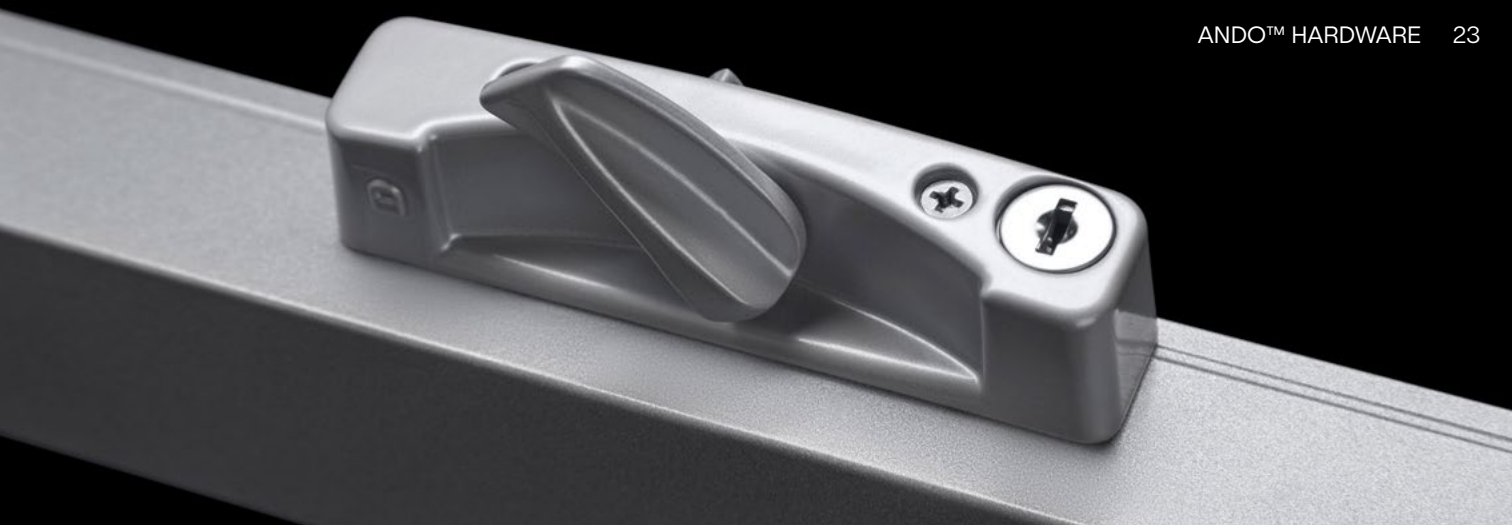

SS Stainless Steel

BAL-40 Tested

# Recessed Finger Pull

This alternative to a sliding door or window handle offers a more understated look.

Available in stainless steel finish only.

Suitable for use with:

- 618** MAGNUM™ Sliding Door
- 50** Commercial Door (Single Beaded)
- 52** Commercial Door (Double Beaded)
- 702** SlideMASTER™ Sliding Door (External Sliding)
- 704** SlideMASTER™ Sliding Door (Internal Sliding)
- 731** Thermally Broken Sliding Door
- 852S** Thermally Broken Sliding Door

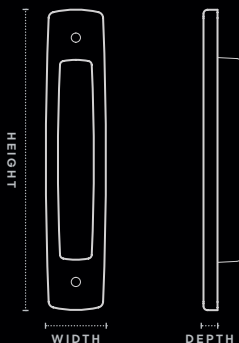

**Height** 150mm  
**Width** 30mm  
**Depth** 7mm



# Manual Chain Winder

The ANDO™ manual chainwinder is designed to suit Vantage® and Elevate™ awning window systems.

Incorporating a corrosion resistant Polesium™ body and adjustable 316-grade stainless steel chain, the ANDO™ manual chainwinder delivers a reliable and stylish solution which can be colour matched to the custom powdercoat finish of your new windows.

The indicator allows you to see whether the winder is locked or unlocked at a glance.

Integrated within the body is a Safe4Kids™ restriction option that limits how wide the window can open to minimise the risk of falls.

Suitable for use with:

- 516** Residential Awning Window (50mm)
- 517** Residential Awning Window (102mm)
- 755** ComfortEDGE™ Awning Window
- 756** High Performance Awning Window (75mm)
- 616** MAGNUM™ Awning Window
- 456** Commercial Awning Window
- 466** Architectural Awning Window
- 726** Thermally Broken Awning Window



**Height** 41mm  
**Width** 278mm  
**Depth** 45mm





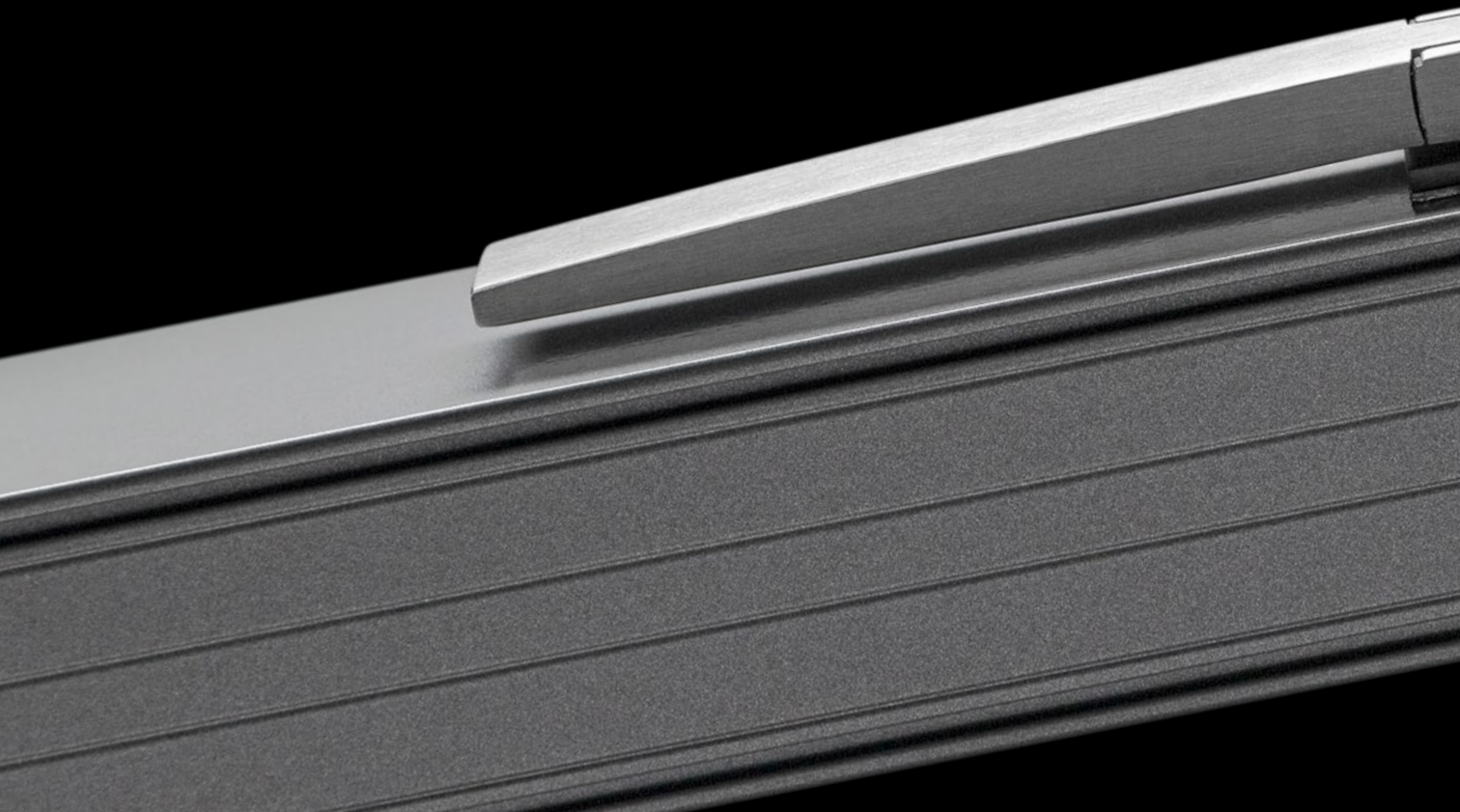

**icon**

Strength & Integrity





 Stainless Steel

 BAL-40 Tested

# Sliding Door Handle

This handle makes a real statement. Its square-form offers a firm yet comfortable grip and is ideal for larger sliding door panels in residential and commercial applications.

Manufactured from 316-stainless steel, this handle is ideal for use in harsh environmental applications and high traffic areas.

Available in two lengths: 300mm and 600mm.

Suitable for use with:

- 618** MAGNUM™ Sliding Door
- 702** SlideMASTER™ Sliding Door (External Sliding)
- 704** SlideMASTER™ Sliding Door (Internal Sliding)
- 704R** SlideMASTER™ Sliding Door (Recessed)
- 704B** SlideMASTER™ Sliding Door (Bottom Rolling)
- 704T** SlideMASTER™ Sliding Door (Top Hung)
- 731** Thermally Broken Sliding Door
- 852S** Thermally Broken Sliding Door

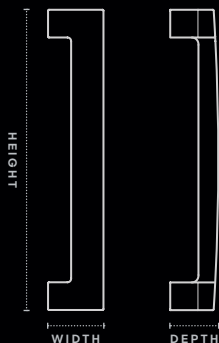

**Height** 325mm  
**Width** 60mm  
**Depth** 52mm

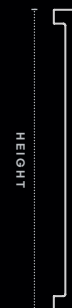

**Height** 625mm  
**Width** 60mm  
**Depth** 52mm



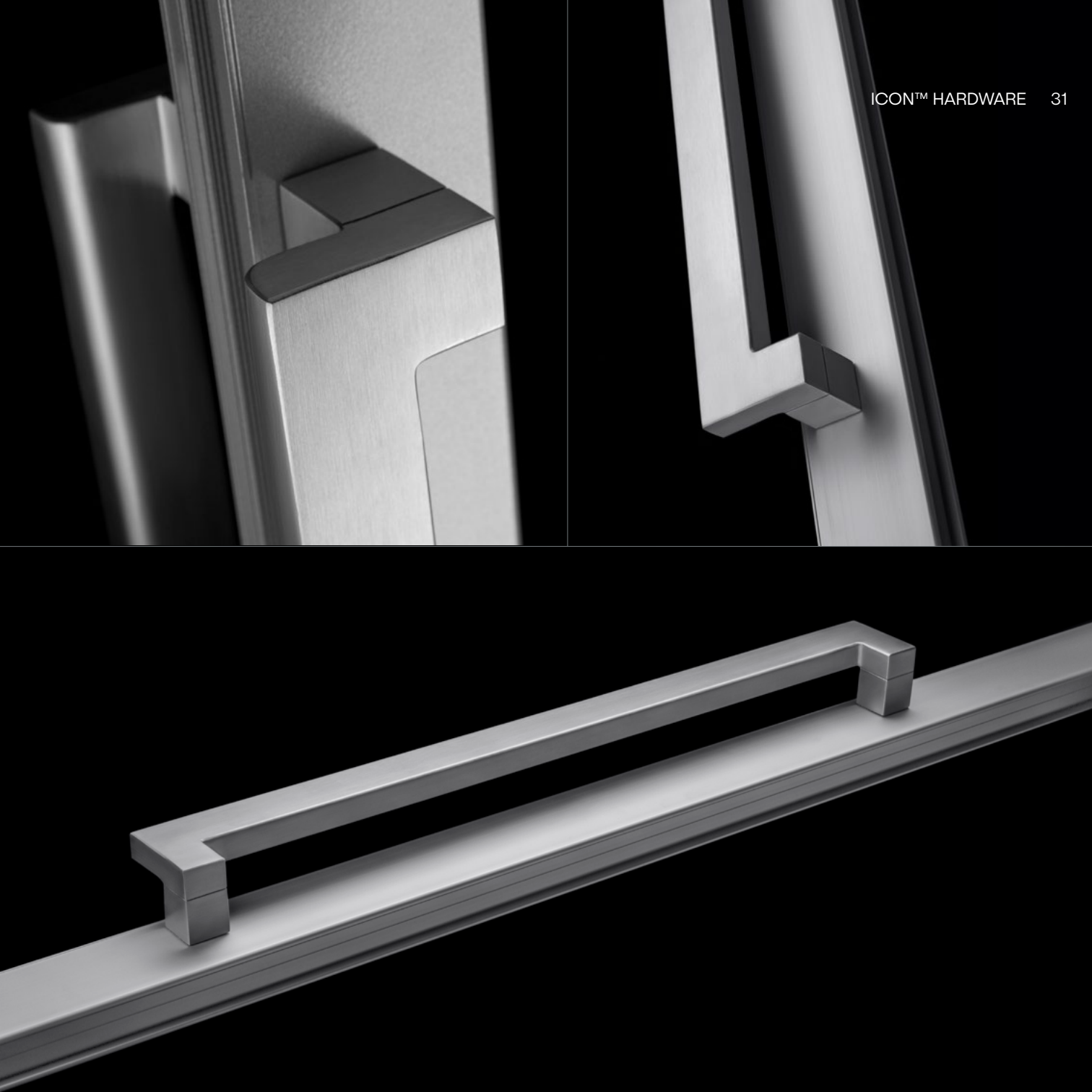

SS Stainless Steel

BAL-40 Tested

# Hinged Door Lock

A clean and compact hinged door handle available in 2-point and 4-point lever compression options.

The grip has a gently radiused front face and a curved back for comfortable hand-hold.

The ICON™ Hinged Door Lock is highly durable and tested for use with large residential and commercial hinged door applications.

Suitable for use with:

- 548** High Performance Bi-fold Door
- 549** Hinged Entry Door
- 50** Commercial Door (Single Beaded)
- 51** Light Commercial Door
- 52** Commercial Door (Double Beaded)
- 410** FoldMASTER™ Bi-fold Door (Bottom Rolling)
- 411** FoldMASTER™ Bi-fold Door (Top Hung)
- 412** ViewMASTER™ Bi-fold Door (Bottom Rolling)
- 650** Architectural Hinged Door
- 729** Thermally Broken Hinged Door
- 730** Thermally Broken Bi-fold Door
- 831** Thermally Broken E3 Bi-fold Door
- 832** Thermally Broken Bi-fold Door
- 852** Thermally Broken Door

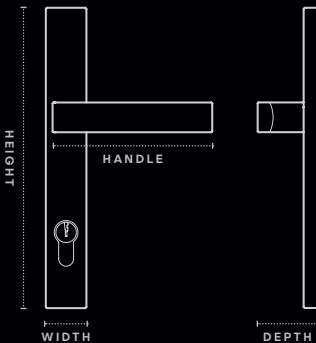

**Height** 222mm  
**Width** 30mm  
**Handle** 118mm  
**Depth** 44mm



SS Stainless Steel

BAL-40 Tested

# Bi-fold Operator

This swivel operator pushes stainless steel locking bolts into the frame at the top and bottom of the panel. The square corners of the handle are combined with radiused top and bottom surfaces to soften the aesthetics.

Suitable for use with:

- 546** High Performance Bi-fold Window
- 548** High Performance Bi-fold Door
- 410** FoldMASTER™ Bi-fold Door (Bottom Rolling)
- 411** FoldMASTER™ Bi-fold Door (Top Hung)
- 412** ViewMASTER™ Bi-fold Door (Bottom Rolling)
- 730** Thermally Broken Bi-fold Door
- 831** Thermally Broken E3 Bi-fold Door
- 832** Thermally Broken Bi-fold Door

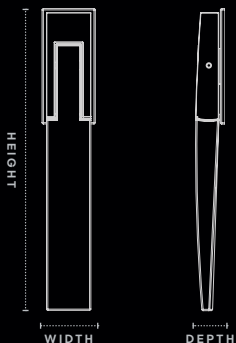

**Height** 170mm  
**Width** 25mm  
**Depth** 16.5mm



# Casement Latch

Designed to suit residential awnings and casement windows, the main feature of this latch are its bold square-edges and radiused styling.

The 316 grade stainless steel makes it a classy and superior quality selection for use in coastal locations.

Suitable for use with:

- 516** Residential Awning Window (50mm)
- 517** Residential Awning Window (102mm)
- 616** MAGNUM™ Awning Window
- 456** Commercial Awning Window
- 466** Architectural Awning Window
- 726** Thermally Broken Awning Window

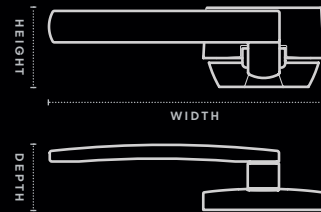
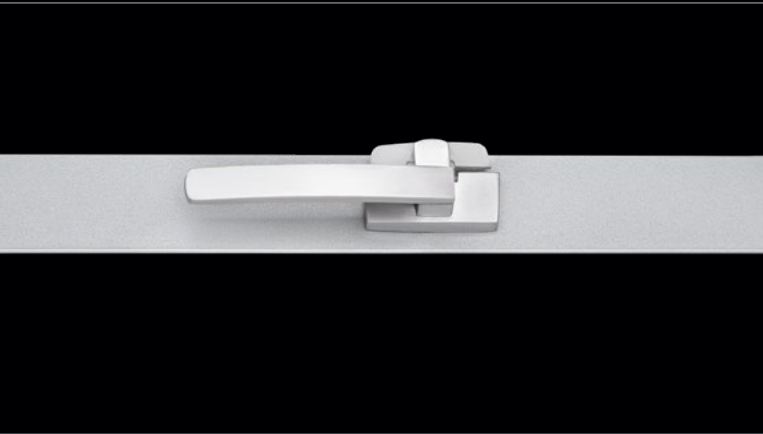

**Height** 37.2mm

**Width** 131mm

**Depth** 31mm



# Recessed Flush Pull

An ideal choice for a more minimalist finish where understated hardware is preferred, flush pulls are an excellent choice where consideration is needed around drapes and blinds

Suitable for use with:

- 618** MAGNUM™ Sliding Door
- 702** SlideMASTER™ Sliding Door (External Sliding)
- 704** SlideMASTER™ Sliding Door (Internal Sliding)
- 704R** SlideMASTER™ Sliding Door (Recessed)
- 704B** SlideMASTER™ Sliding Door (Bottom Rolling)
- 704T** SlideMASTER™ Sliding Door (Top Hung)
- 731** Thermally Broken Sliding Door
- 852S** Thermally Broken Sliding Door

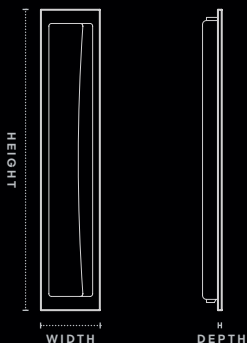

**Height** 230mm  
**Width** 45mm  
**Depth** 3mm



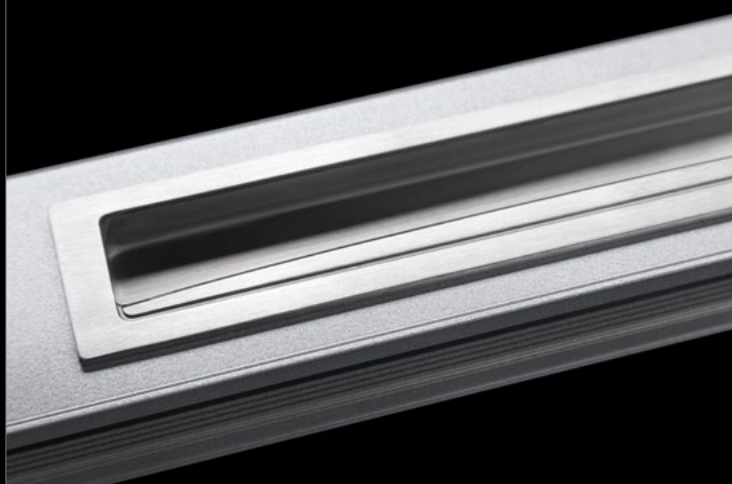

# Sliding Window Lock

A compact, streamlined window lock for a neat, flush finish. Push operator into body to slide window open or closed. Key-lockable for security and peace of mind.

Suitable for use with:

- 601** MAGNUM™ Sliding Window (Beaded Fixed Light)
- 602** MAGNUM™ Sliding Window (Double Sash Design)
- 461** Apartment Sliding Window
- 462** Architectural Sliding Window
- 662** Architectural Sliding Window (150mm)

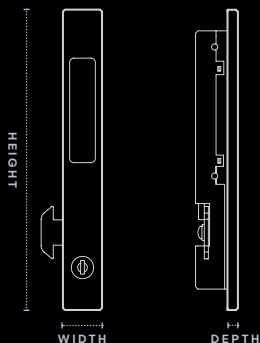

**Height** 160mm  
**Width** 24mm  
**Depth** 6.5mm

NOTE: Not suitable for FXXF window configurations.



# ISEO Mortice Lock

Designed specifically for high end sliding doors, the low profile face plate ensures seamless stacking with no obstruction or interference.

This key lockable mortice lock and finger pull is an ideal choice for cavity sliding door applications

Suitable for use with:

- 618** MAGNUM™ Sliding Door
- 704** SlideMASTER™ Sliding Door (Internal Sliding)
- 704R** SlideMASTER™ Sliding Door (Recessed)
- 704B** SlideMASTER™ Sliding Door (Bottom Rolling)
- 704T** SlideMASTER™ Sliding Door (Top Hung)

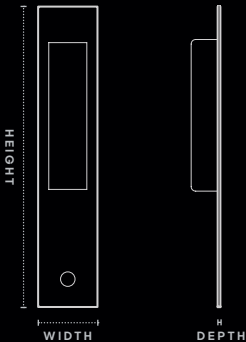

**Height** 165mm  
**Width** 32mm  
**Depth** 1.5mm



The conveniently located hidden finger pull allows the panel to be pulled out for operation



Contemporary Style

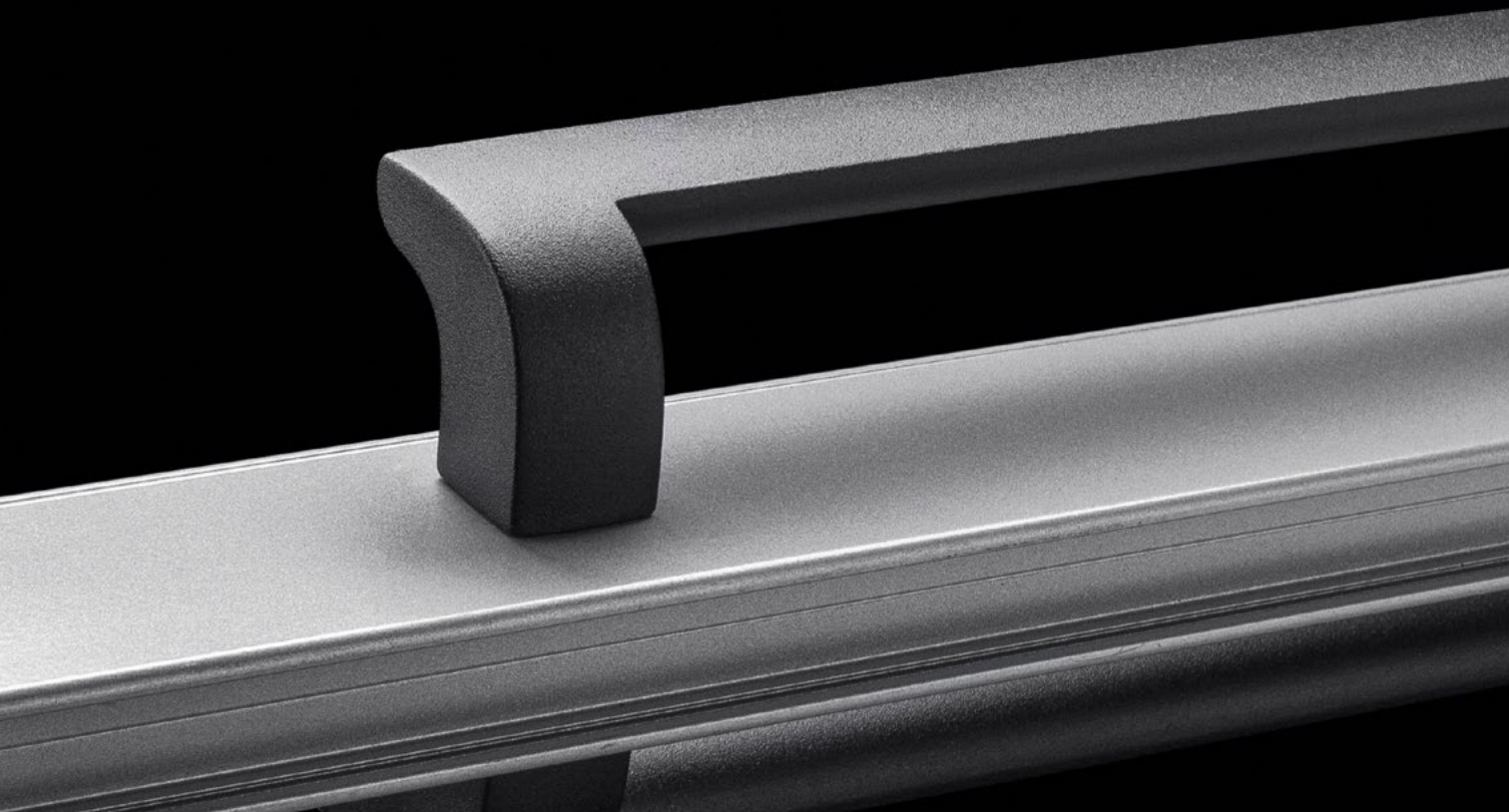



# D-Pull Sliding Door Handle

Bold and stylish, the MIRO™ sliding door handle offers simplicity and practicality with its soft rounded edges. The handle is disability access compliant.

Featuring Enduratec™ Finish Technology, its the perfect mix of durability, simplicity and comfort in mild and harsh conditions alike.

Suitable for use with:

- 618** MAGNUM™ Sliding Door
- 50** Commercial Door (Single Beaded)
- 51** Light Commercial Door
- 52** Commercial Door (Double Beaded)
- 702** SlideMASTER™ Sliding Door (External Sliding)
- 704** SlideMASTER™ Sliding Door (Internal Sliding)
- 704R** SlideMASTER™ Sliding Door (Recessed)
- 704B** SlideMASTER™ Sliding Door (Bottom Rolling)
- 704T** SlideMASTER™ Sliding Door (Top Hung)
- 731** Thermally Broken Sliding Door
- 852S** Thermally Broken Sliding Door

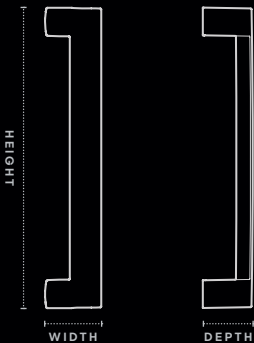

**Height** 325mm  
**Width** 61mm  
**Depth** 54mm





# Single Point Sliding Door Lock

Bold in design with modern, curved lines, the MIRO™ Sliding door lock mounts on the door and offers an integrated single point lock delivering a solid and functional statement to any surrounding.

The textured matt exterior and Enduratec™ Finish Technology makes it simple to use and maintain as well as a perfect choice for harsh environments.

Suitable for use with:

- 541** Residential Sliding Door
- 542** Residential Stacking Sliding Door
- 618** MAGNUM™ Sliding Door
- 442** Commercial Stacking Sliding Door
- 642** Commercial Stacking Sliding Door (150mm)
- 471** Apartment Sliding Door
- 704** SlideMASTER™ Sliding Door (Internal Sliding)
- 704R** SlideMASTER™ Sliding Door (Recessed)
- 704B** SlideMASTER™ Sliding Door (Bottom Rolling)
- 704T** SlideMASTER™ Sliding Door (Top Hung)

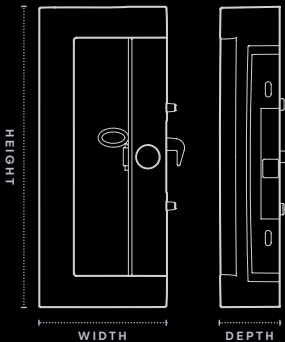

**Height** 235mm  
**Width** 100mm  
**Depth** 47mm



# Hinged Door Lock

With its contemporary curved styling, this handle has an elegant return for smooth operation.

Not only stylish, the handle is disability access compliant and uses Enduratedec™ Finish Technology to maximise durability and simplicity.

Available as:

- 2-point lock – single locking
- 4-point lock – multi locking
- lever compression locking

Suitable for use with:

- 548** High Performance Bi-fold Door
- 549** Hinged Entry Door
- 50** Commercial Door (Single Beaded)
- 51** Light Commercial Door
- 52** Commercial Door (Double Beaded)
- 410** FoldMASTER™ Bi-fold Door (Bottom Rolling)
- 411** FoldMASTER™ Bi-fold Door (Top Hung)
- 412** ViewMASTER™ Bi-fold Door (Bottom Rolling)
- 650** Architectural Hinged Door
- 729** Thermally Broken Hinged Door
- 730** Thermally Broken Bi-fold Door
- 831** Thermally Broken E3 Bi-fold Door
- 832** Thermally Broken Bi-fold Door
- 852** Thermally Broken Door

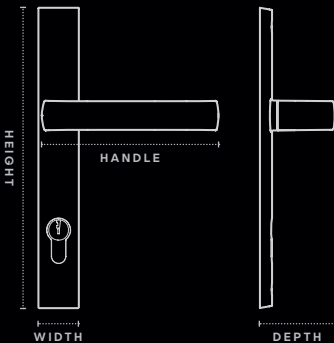

**Height** 223mm  
**Width** 56mm  
**Handle** 134mm  
**Depth** 56mm



# Bi-fold Operator

The contemporary design and matt black styling offers a clean and functional finish for bifold window and doors.

The simplicity of the design coupled with its incorporation of Enduratec™ Finish Technology makes it durable and easy to maintain.

Suitable for use with:

- 546** High Performance Bi-fold Window
- 548** High Performance Bi-fold Door
- 410** FoldMASTER™ Bi-fold Door (Bottom Rolling)
- 411** FoldMASTER™ Bi-fold Door (Top Hung)
- 412** ViewMASTER™ Bi-fold Door (Bottom Rolling)
- 730** Thermally Broken Bi-fold Door
- 831** Thermally Broken E3 Bi-fold Door
- 832** Thermally Broken Bi-fold Door

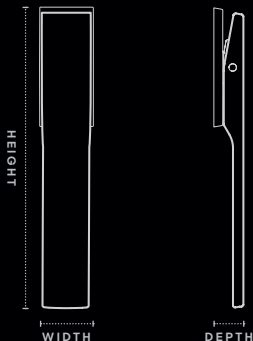

**Height** 149mm  
**Width** 27mm  
**Depth** 15mm

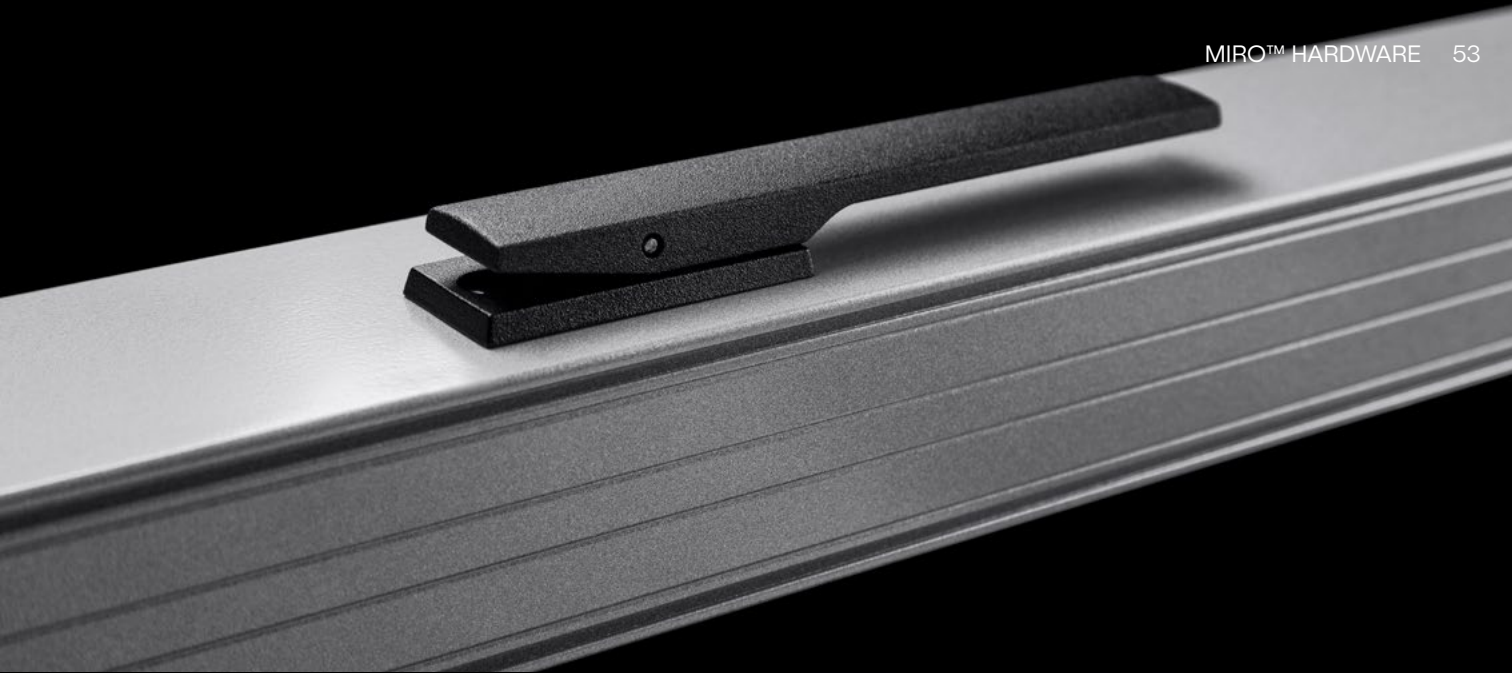

# Recessed Flush Pull

A sleek, understated addition to your sliding door, the MIRO™ recessed flush pull incorporates a gently curved faceplate with scalloped highlights.

The recessed pull enables easy door operation without interfering with blinds or curtains.

It uses Enduratec™ Finish Technology.

Suitable for use with:

- 618** MAGNUM™ Sliding Door
- 702** SlideMASTER™ Sliding Door (External Sliding)
- 704** SlideMASTER™ Sliding Door (Internal Sliding)
- 704R** SlideMASTER™ Sliding Door (Recessed)
- 704B** SlideMASTER™ Sliding Door (Bottom Rolling)
- 704T** SlideMASTER™ Sliding Door (Top Hung)
- 731** Thermally Broken Sliding Door
- 852S** Thermally Broken Sliding Door

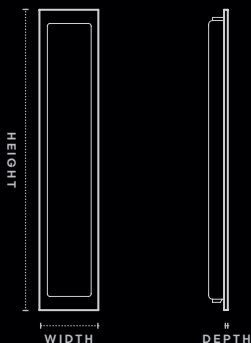

**Height** 230mm  
**Width** 45mm  
**Depth** 2mm





# Single Chain Winder

Featuring a textured matte finish and AWS' exclusive Enduratec™ technology, this is the ideal solution for use in harsh environmental applications. Incorporating a key lock system and indicator, clearly see if the winder is in the locked or unlocked position prior to activating.

The indicator allows you to see whether the winder is locked or unlocked at a glance.

Integrated within the body is a Safe4Kids™ restriction option that limits how wide the window can open to minimise the risk of falls.

Suitable for use with:

- 516** Residential Awning Window (50mm)
- 517** Residential Awning Window (102mm)
- 755** ComfortEDGE™ Awning Window
- 756** High Performance Awning Window (75mm)
- 616** MAGNUM™ Awning Window
- 456** Commercial Awning Window
- 665** Commercial Awning Window
- 466** Architectural Awning Window
- 467** Architectural Awning Window
- 726** Thermally Broken Awning Window



**Height** 41mm  
**Width** 278mm  
**Depth** 45mm





 Accessibility Focused



Optional Special Access Lever (SAL) handle available to improve operability for those with reduced dexterity and comply with AS1428:2009.

# Twin Chain Winder

The MIRO™ twin chainwinder delivers a reliable and durable solution to even our largest awning window systems. The wider span allows greater flexibility in awning window design.

Like the MIRO™ Single Chain Winder, it incorporates Enduratec™ technology to maximise durability and capability in coastal applications and other harsh environmental conditions.

Suitable for use with:

- 516** Residential Awning Window (50mm)
- 517** Residential Awning Window (102mm)
- 755** ComfortEDGE™ Awning Window
- 756** High Performance Awning Window (75mm)
- 616** MAGNUM™ Awning Window
- 456** Commercial Awning Window
- 665** Commercial Awning Window
- 466** Architectural Awning Window
- 467** Architectural Awning Window
- 726** Thermally Broken Awning Window

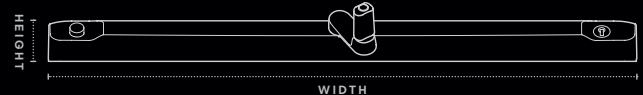

**Height** 34.5mm  
**Width** 499.5mm  
**Depth** 48mm

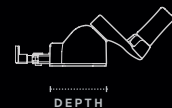



 Accessibility Focused



Optional Special Access Lever (SAL) handle available to improve operability for those with reduced dexterity and comply with AS1428:2009 Section 13.5 (Disability Access) and Livable Housing Guidelines.

# Additional Hardware Options



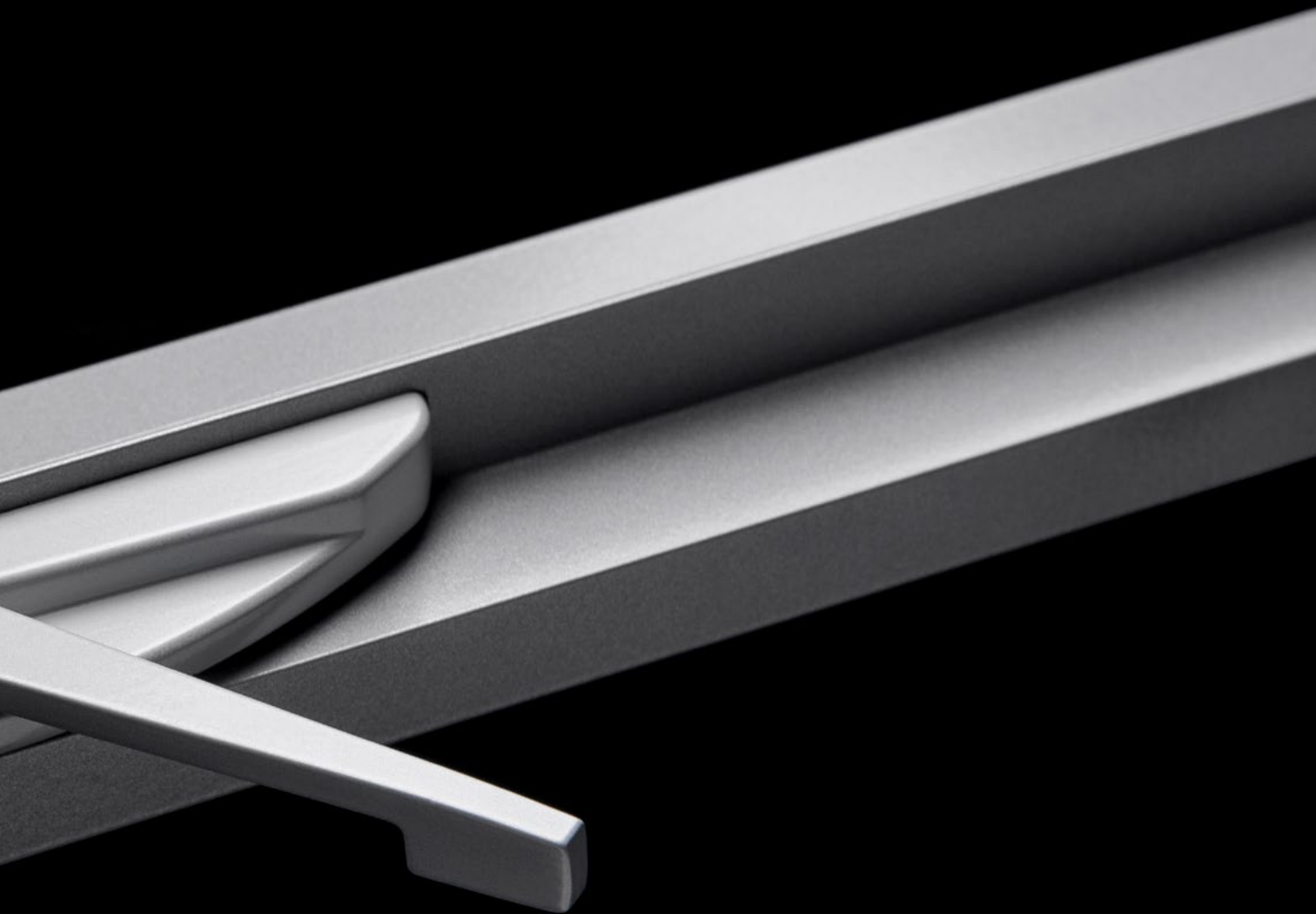

# TRUTH™ Awning Winder

Truth™ compact awning scissor winders are perfect for large awning windows. Tried and tested, Truth™ winders are strong and won't budge under windload.

Available in a selected range of colour matched powder coat finishes.

Suitable for use with:

- 616** MAGNUM™ Awning/Casement Window
- 467** Architectural Awning/Casement Window
- 468** Truth™ Awning Window/Casement (100mm)
- 668** Truth™ Awning Window/Casement (150mm)
- 726** Thermally Broken Awning/Casement Window

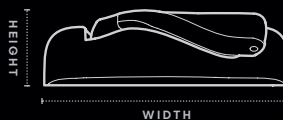

Winder (pictured)

**Height** 34mm  
**Width** 135mm  
**Depth** 40mm



Winder (keyed)

**Height** 34mm  
**Width** 170mm  
**Depth** 37mm



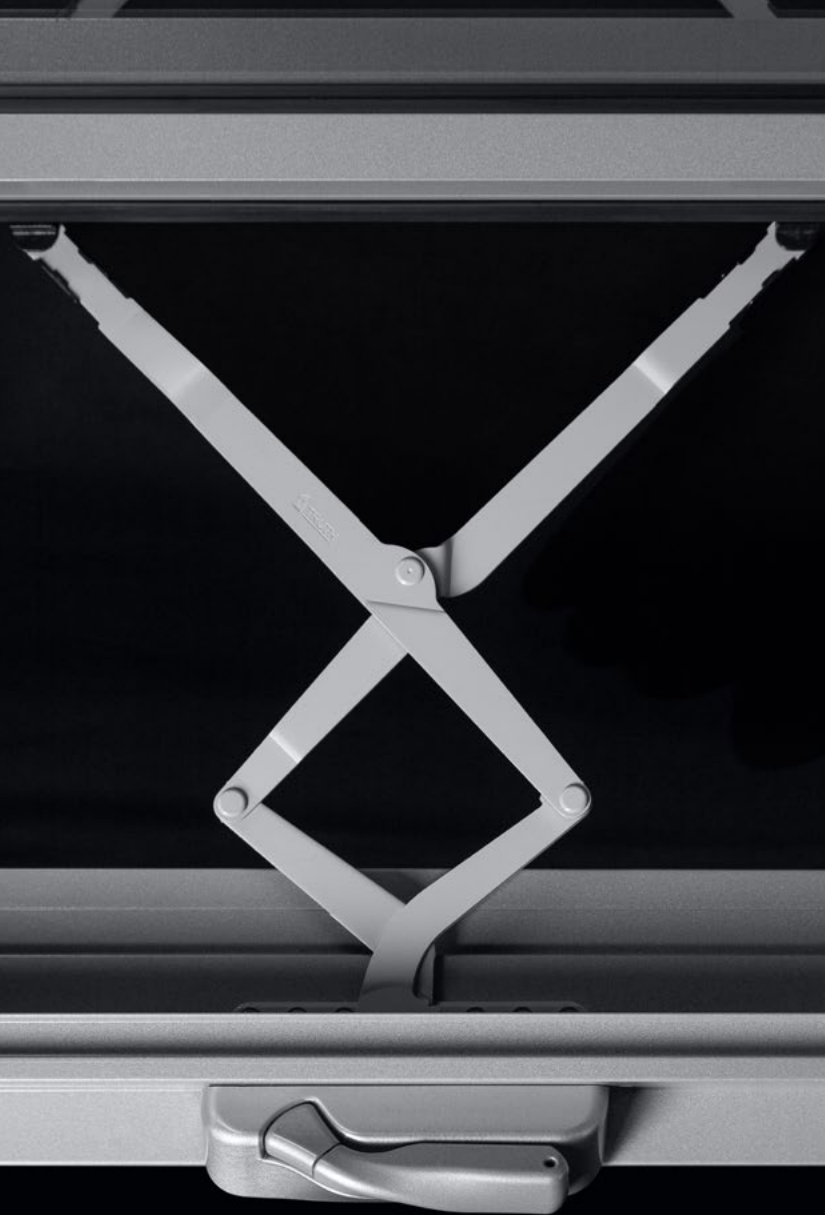

Key locking version also available.

# TRUTH™ Casement Winder

The Truth™ Casement Winder is a compact and stylish scissor winder ideal for large casement windows and offers 90-degree opening. This winder has been rigorously tested and won't open or close under wind load.

Available in a selected range of colour matched powder coat finishes.

Suitable for use with:

- 616** MAGNUM™ Awning/Casement Window
- 467** Architectural Awning/Casement Window
- 468** Truth™ Awning Window/Casement (100mm)
- 668** Truth™ Awning Window/Casement (150mm)
- 726** Thermally Broken Awning/Casement Window

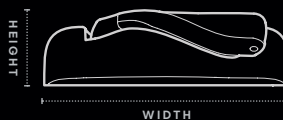

Winder (pictured)

**Height** 34mm  
**Width** 135mm  
**Depth** 40mm



Winder (keyed)

**Height** 34mm  
**Width** 170mm  
**Depth** 37mm



Key locking version also available.



# Meeting Stile Mortice Lock

Designed exclusively for use with the Elevate™ range of SlideMASTER™ flush finish doors, the Meeting Stile Mortice Lock integrates neatly into a central panel to be fully concealed for maximum glass site lines.

The simple operating method provides ease of use and multipoint locking for excellent security.

Available in a range of powder coat finishes to ensure the lock can be colour matched for a truly discreet appearance.

Exclusively used with:

**704FBR** SlideMASTER™ Sliding Door (Flush Bottom Rolling)

**704FTH** SlideMASTER™ Sliding Door (Flush Top Hung)

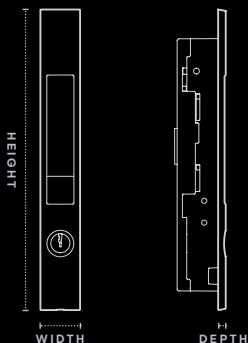

**Height** 250mm  
**Width** 33mm  
**Depth** 6.5mm



# Flush Pull Handle

Architecturally inspired, the flush pull handle is designed exclusively for use with the Elevate range of SlideMASTER™ flush finish doors.

The colour matched, aluminium pull handle provides a strong D-Pull grip which nests neatly around the panel for a minimal and integrated appearance.

Exclusively used with:

**704FBR** SlideMASTER™ Sliding Door (Flush Bottom Rolling)

**704FTH** SlideMASTER™ Sliding Door (Flush Top Hung)

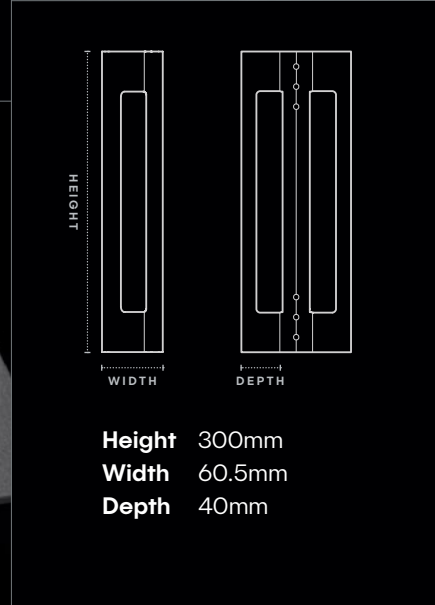
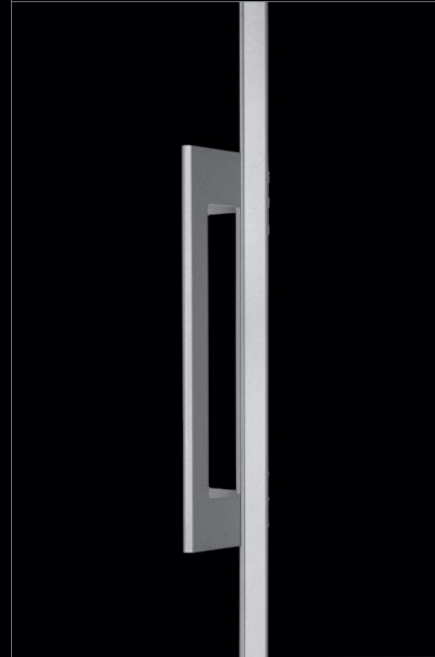

**Height** 300mm  
**Width** 60.5mm  
**Depth** 40mm

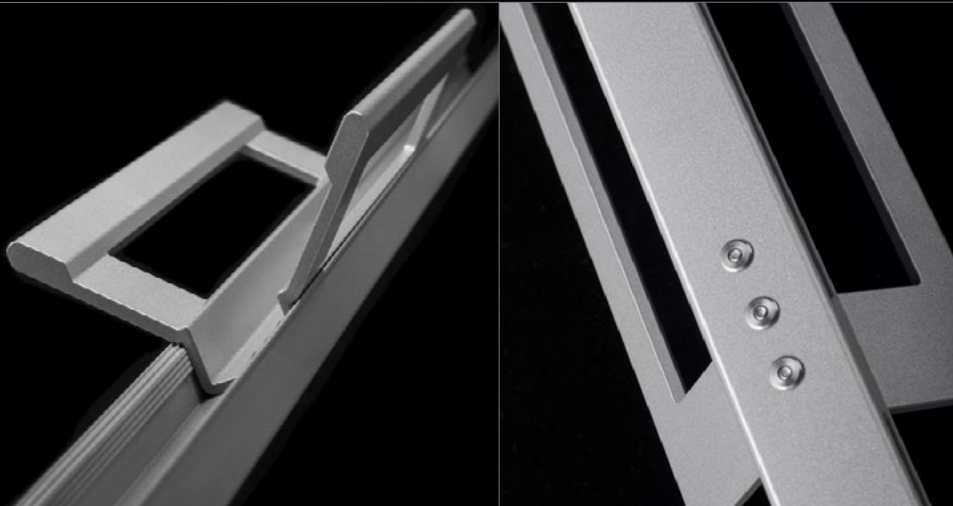

# Lift Slide Handle

Designed exclusively for use with the Elevate™ SlideMASTER™ Lift Slide Door, the handle utilises a 180° operating arc to activate lift mechanisms within the sliding door panel for effortless operation. Reverse rotation compresses the panel against the door seals for security and air tightness.

The clean sharp styling of the handle allows it to integrate with the ICON™ hardware range when coordinating the hardware selection for your home.

Exclusively used with:

**704LS** SlideMASTER™ Sliding Door (Lift Slide)

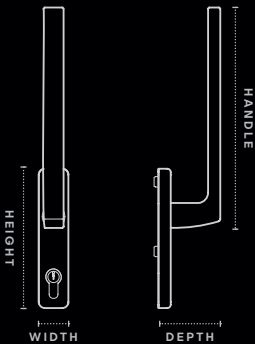

**Handle** 253mm  
**Height** 160mm  
**Width** 34mm  
**Depth** 71mm

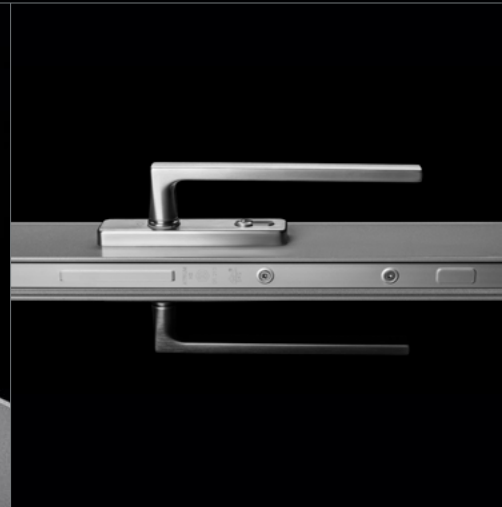

# Universal "EPEC" Electronic Cylinder

Designed to complement the full range of MIRO™, ICON™ and ANDO™ hardware the "EPEC" Electronic Cylinder allows keyless entry to be easily implemented within your home or commercial building project. Instantly upgrade existing Euro Cylinder lock bodies to smart locks!

The "EPEC" system enables you to create up to 12 unique user codes for controlled access with the ability to wipe or reset codes as needed delivering flexible security options.

With up to 3 year battery life and 9,000 cycles this is a smart and flexible way to implement electronic locking within your home.



# Performance Side Latch

Used in conjunction with the single or twin manual chain winders, performance latches add additional locking points for awning windows

They may be recommended by your fabricator for applications

subjected to high wind loads or in situations where awning windows are wide and require additional locking points to provide security and integrity.

Suitable for use with:

- 516** Residential Awning Window (50mm)
- 517** Residential Awning Window (102mm)
- 756** High Performance Awning Window (75mm Frame)
- 616** MAGNUM™ Awning Window
- 456** Commercial Awning Window
- 665** Commercial Awning Window
- 466** Architectural Awning Window
- 726** Thermally Broken Casement Window
- 804** Thermally Broken Casement Window
- 824** Thermally Broken Casement Window

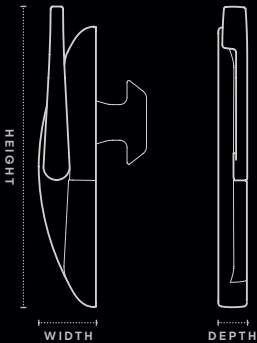

**Height** 157.5mm  
**Width** 32mm  
**Depth** 16mm



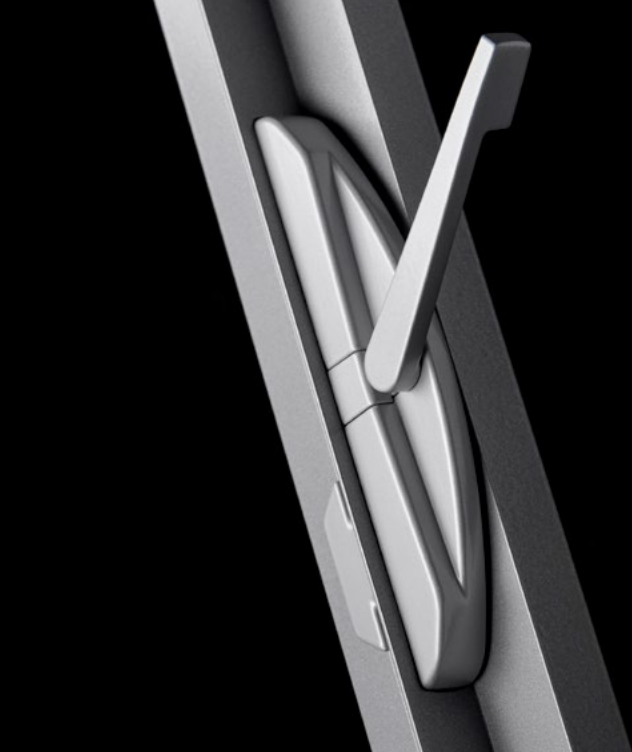



**Commercial Series** Commercial ThermalHEART

**ANDO™**

	50/52	442	452	453	456	461	471	642	665	831	832	852	824	826
Single Point Sliding Door Lock		●					●	●						
Twin Point Sliding Door Lock		●					●	●						
Slimline Sliding Door Lock		●					●	●						
Sliding Door Handle	●											●		
Hinged Door Lock (2-point)	●									●	●	●		
Hinged Door Lock (4-point)	●									●	●	●		
Lever Compression Lock	●									●	●	●		
Bi-fold Operator										●	●			
Sliding Window Lock						●								
Double Hung Lock				●										
Recessed Finger Pull														
Manual Chain winder						●			●					

**ICON™**

Sliding Door Handle	●											●		
Hinged Door Lock (2-point)	●									●	●	●		
Hinged Door Lock (4-point)	●									●	●	●		
Lever Compression Lock	●									●	●	●		
Bi-fold Operator										●	●			
Casement Latch					●									
Recessed Flush Pull												●		
Sliding Window Lock						●								
ISEO Mortice Lock														

**MIRO™**

Sliding Door Handle	●											●		
Single Point Sliding Door Lock		●					●	●						
Hinged Door Lock	●									●	●	●		
Lever Compression Lock	●									●	●	●		
Bi-fold Operator										●	●			
Recessed Flush Pull												●		
Single Chain winder						●			●					
Twin Chain winder						●			●					

Truth™ winder									●				●	●
---------------	--	--	--	--	--	--	--	--	---	--	--	--	---	---



# Hardware Compatibility

	Residential Series						Designer Series						Designer ThermalHEART™					
	514	516	517	541	542	755	756	546	548	549	601/2	613	616	618	726	729	730	731
ANDOTM	Single Point Sliding Door Lock				●	●								●				
	Twin Point Sliding Door Lock				●	●								●				
	Slimline Sliding Door Lock				●	●					●			●				
	Sliding Door Handle													●				●
	Hinged Door Lock (2-point)								●	●						●	●	
	Hinged Door Lock (4-point)								●	●						●	●	
	Lever Compression Lock								●	●						●	●	
	Bi-fold Operator								●	●							●	
	Sliding Window Lock											●						
	Double Hung Lock	●											●					
	Recessed Finger Pull														●			●
	Manual Chain winder		●	●			●	●						●		●		
	ICONTM	Sliding Door Handle													●			
Hinged Door Lock (2-point)								●	●							●	●	
Hinged Door Lock (4-point)								●	●							●	●	
Lever Compression Lock								●	●							●	●	
Bi-fold Operator								●	●								●	
Casement Latch			●	●									●		●			
Recessed Flush Pull														●				●
Sliding Window Lock												●						
ISEO Mortice Lock														●				
MIROTM	Sliding Door Handle													●				●
	Single Point Sliding Door Lock				●	●								●				
	Hinged Door Lock							●	●							●	●	
	Lever Compression Lock							●	●							●	●	
	Bi-fold Operator							●	●								●	
	Recessed Flush Pull													●				●
	Single Chain winder		●	●			●	●					●		●			
	Twin Chain winder						●	●					●		●			
Truth™ winder												●		●				

# Colour

ANDO™ and Truth™ hardware is available colour matched to a range of powder coat colours.

## Standard Colours

## Selected Pearls

## Popular Colours

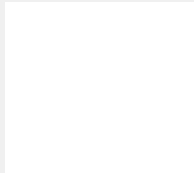

Pearl White  
GLOSS 1004



APO Grey  
SATIN 1001

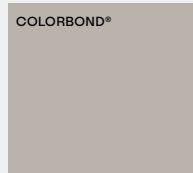

Dune®  
MATT 1010



Citi  
PEARL MATT 3002

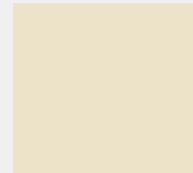

Magnolia  
GLOSS 2012



Doeskin  
SATIN 2006

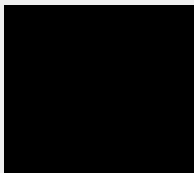

Custom Black  
MATT 1002

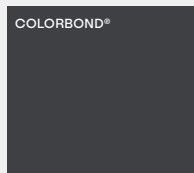

Monument®  
MATT 1011



Woodland Grey®  
MATT 1008



Silver Medallist  
PEARL SATIN 3005

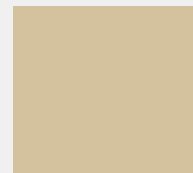

Stone Beige  
MATT 2031

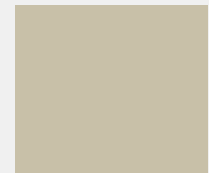

Pottery  
SATIN 2017



Surfmist®  
MATT 1013

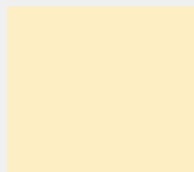

Primrose  
GLOSS 1005

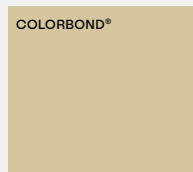

Paperbark®  
MATT 1012

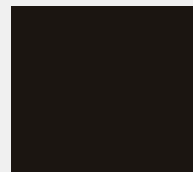

Charcoal Metallic  
GLOSS 3001

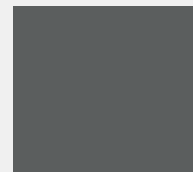

Notre Dame  
GLOSS 2014

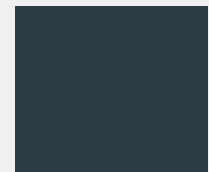

Dark Grey  
MATT 2005

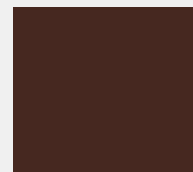

Hammersley Brown  
SATIN 2008

NOTE The finishes displayed on this page are a guide only and may not be actual representations of the actual finish. For powder coat samples, you can order samples from the colour page on the Vantage or Elevate website. Your local Vantage and Elevate supplier may also have samples by request. For custom powder coat requests, see your local fabricator for more information.

# Care & Maintenance

## Powder Coated Hardware

Like any other painted surface, powder coated hardware performs at its best when it is properly cared for. Keeping the surface free from pollutants and environmental contaminants will give you the maximum benefit and long-lasting performance from your powder coated surface. This is particularly important in harsh locations such as beachfronts, severe marine environments or areas of high industrial pollution.

### Recommended cleaning

Gentle clean with a soft brush and mild detergent, followed by a fresh water rinse, will maintain the long-term performance of your powder coated products. In rural or normal urban environments, cleaning should occur every six (6) months.

In particularly harsh locations such as beachfronts, severe marine environments or areas of high industrial pollution, cleaning should occur every three (3) months.

Do not use strong solvents, abrasive cleaning products or any product recommended for thinning paints.

If you need to remove splashed paint, sealants or mastics from your powder coated products, use white spirits, carry out cleaning in shade and during cooler temperatures using a soft cloth and gentle wiping only.

We recommend that prior to using any cleaning agent on your hardware, you test a small non-visible area of your powder coated product to ensure that no visual colour change or damage will occur.

## Stainless Steel Hardware

Stainless steels are very resistant to rust, however this does not mean that they are immune to it. Stainless steel will rust, and must be kept clean and free from contaminants. Frequent cleaning is a requirement. Stainless steel will develop discolouration, rust spots, and corrosion brought about by environmental and installation conditions.

Environments with exposure to the following substances should be avoided:

- Chlorine based (bleach) products and cleaners.
- Hydrochloric acid (commonly used for tile and concrete cleaning).
- Cement dust.
- Soap concentrates.
- Water with high iron content (i.e. bore water).

### Removing Tea Stains and marks

One of the advantages of stainless steel hardware is that any rust spots can be easily removed and generally the product will return to its "new" state with appropriate cleaning. Most discolouration can be removed with a mildly abrasive cleaner (AJAX, JIF, Brasso etc.). Heavier corrosion and rust can be removed using a Scotch-Brite™ pad or stainless steel scourer. Do not use steel wool, as this will leave residues of steel which will rust. After cleaning, the product should be rinsed free of all cleaning product residue with fresh water.

With proper maintenance, stainless steel will maintain its lustre and appearance indefinitely.

# Hardware Warranty

All hardware products supplied by AWS are covered by supplier warranties. The specific details of product warranty vary between ranges. In general, the following warranty considerations apply:

Hardware items are warranted to be free from defects in material and workmanship for a period of six (6) years from the date of purchase.

Various exclusions may apply, including but not limited to:

- Misuse, abuse, accidental or intentional damage, improper or negligent adjustment or operation by the purchaser,
- Improper or negligent maintenance or installation,
- Inaccurate or incorrect site or operational specifications,
- Repair or modification
- Use contrary to the manufacturer's instructions
- Use of replacement parts other than authorised parts,
- 'Tea Staining' on stainless steel,
- Corrosion related damage,
- Tarnish or wear on soft finishes

Please speak with your fabricator to request a copy of the appropriate product warranty for the hardware items you choose.





## Hardware solutions for your windows & doors.

For more information and to find your local Vantage® suppliers:

**[vantagewindows.com.au](http://vantagewindows.com.au)**

For design inspiration & tips, follow us:

 **[vantagewindowsaus](https://www.instagram.com/vantagewindowsaus)**

 **[vantageaustralia](https://www.facebook.com/vantageaustralia)**



**ABN 48 067 950 903**

### HEAD OFFICE

76-78 Jedda Road,  
Prestons NSW 2170

PO BOX 311  
Liverpool NSW 1871

### HAVE QUESTIONS?

Call us at 1300 026 189 or email [marketing@awsaustralia.com.au](mailto:marketing@awsaustralia.com.au)

